



DIVAN D'EXAMEN ÉLECTRIQUE
POWER EXAMINATION COUCH

quest[®]



quest®

LA RÉFÉRENCE DES DIVANS À HAUTEUR VARIABLE THE REFERENCE FOR POWER COUCHES

CONFORT COMFORT

- Largeur utile 100 % de la sellerie
- Mouvements électriques doux
- Possibilité de combiner pédale et commande manuelle (3 connections)
- 100 % of the surface usefull
- Smooth electrical motions
- 3 connections possible (possibility to combine hand and foot control)

HYGIÈNE / HYGIENE

- Système Block'n Roll exclusif (modèles 2050-15/30/50)
- Toutes les parties exposées sont accessibles au nettoyage
- Revêtement avec protection antibactérienne
- Exclusive Block'n Roll system (models 2050-10/30/50)
- All exposed parts are cleanable
- Covering with antibacterial protection

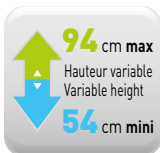

Modèle présenté avec options/accessoires
Products shown with options/accessories

SÉCURITÉ SAFETY

- Pied en H très stable
- Bras d'élévation robustes
- Capacité 200 kg
- Proclive - Déclive (sur certains modèles)
- Batterie pour mouvements d'urgence (option)
- Borne équipotentielle (option)
- Very stable H shaped base
- Sturdy elevation arms
- 200 kg patient weight capacity
- Trendelenburg - reverse trendelenburg (on specific models only)
- Battery for emergency movements (option)
- Equipotential terminal (option)

ACCESSIBILITÉ ACCESSIBILITY

- Hauteur variable de 54 à 94 cm
- Compatible avec un lève-malade
- Variable height from 54 to 94 cm
- Compatible with a hoist



Accueil
Welcome



Position haute
High position



Examen général
General examination



Déclive
Trendelenburg



Proclive
Reverse trendelenburg

CARACTÉRISTIQUES STANDARDS

STANDARD FEATURES

Hauteur variable électrique de 54 à 94 cm
 Structure acier avec finition époxy gris nuage
 Dossier réglable par vérin à gaz ou vérin électrique
 Commande manuelle
 Patins de réglage sous piètement
 Block'n Roll® - Système de roulettes escamotables intégrées
 semi-centralisé [réf : 2050-15, 2050-30 et 2050-50]
 Support rouleau papier (longueur maxi 50 cm - ø 12,5 cm)
 12 cm de dégagement au sol compatible avec le passage d'un lève-personne
 Connexion de 3 commandes possible
 Dispositif médical de classe électrique 2 / Disponible en classe 1 avec option
 2059-01, non compatible avec 85114-01

Electric variable height from 54 to 94 cm
 Steel frame structure with grey epoxy finish
 Gas-spring assisted or electric backrest
 Hand control
 Adjustable levellers under base
 Block'n Roll® - Integrated retractable castor system
 semi centralized (ref: 2050-15, 2050-30 and 2050-50)
 Paper roll holder (max length 50 cm - ø 12,5 cm)
 Mobile hoist compatibility clearance of 12 cm
 Possibility of 3 control connections
 Electrical medical device class 2 / Available in class 1 with option
 2059-01, not compatible with 85114-01

Modèles Models	Patins Levellers	Block'n Roll®	Proclive / Déclive Tredenlenburg Reverse tredenlenburg	Dossier à gaz Gas-spring assisted backrest	Dossier électrique Electric backrest
2050-10	●			●	
2050-15		●		●	
2050-20	●		●	●	
2050-30		●	●	●	
2050-50		●	●		●

Selleries Upholstery

Tous modèles,
à commander séparément /
All models, to order separately

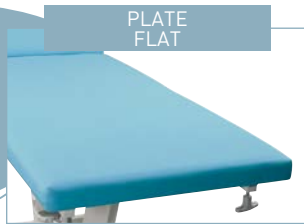

PLATE
FLAT

Largeur / Width 65 cm 600150-65
 Largeur / Width 75 cm 600150-75



A BOURRELETS
LATERAL PADDINGS

Largeur / Width 65 cm 600151-65
 Largeur / Width 75 cm 600151-75



ANATOMIQUE
FORMED

Largeur / Width 73 cm 600150-70

Options*

* A demander impérativement
lors de la commande,
montage usine /
Plant installed, must be
ordered with initial order



81036

4 roues à frein
double galet ø 50 mm
Set of 4 double castors
with brakes ø 50 mm
(pour/for 2050-10/20)



2231-65 / 2231-75
Sellerie/upholstery
65 cm / Sellerie/upholstery
75 cm

Trou pour visage
Face cutout in head cushion
uniquement sur sellerie plate
only with flat upholstery
600150-65 / 600150-75



600000-01

Montage de sellerie
en usine
Factory assembly fitting
of upholstery

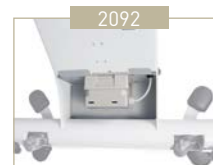

2092

Batterie pour mouvements
d'urgence
Battery for emergency
movements

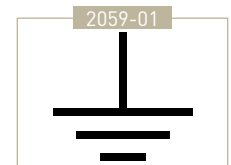

2059-01

Protection terre (classe 1)
+ borne equipotentielle
Earth socket (class 1)
+ equipotential terminal

Accessoires Accessories

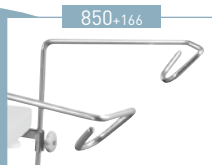

850+166

Paire d'étriers
Pair of stirrups



840+166

Paire d'appui-jambes
plastiques
Pair of plastic legrests



861

Paire de housses
pour appui-jambes
Pair of covers for legrests

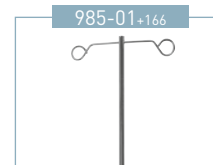

985-01+166

Tige porte-sérum
2 crochets
2 hook IV pole



2985-01+166

Tige porte-sérum
autobloquant 2 crochets
Auto-locking 2 hook IV pole



600150-65C / 600150-75C
Pour sellerie plate/For flat upholstery
65 cm / 75 cm

Protection cristal pied
Plastic cover (foot end)



2536+166

Appui-bras (unitaire)
Armrest (unit)



2537

Housse pour appui-bras
(unitaire)
Cover for armrest (unit)



2056-02

Porte-rouleau réglable
Adjustable paper-roll holder
(350-800 mm)



2054-01

Appui-tête
(pour sellerie anatomique)
Headrest (for formed
upholstery only)

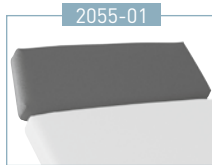

2055-01

Rallonge dossier
Backrest extension

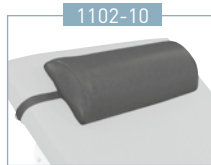

1102-10

Appui-tête 52 cm
Headrest 52 cm

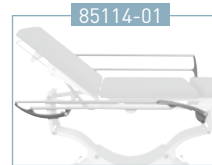

85114-01

Paire de barrières
Pair of barriers
Incompatible avec /
Incompatible with
166, 985-01, 2985-01

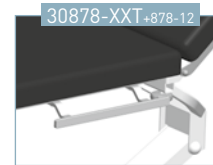

30878-XXT+878-12

Paire de rails tête
Pair of head rails



30878-XXP+878-12

Paire de rails pieds
Pair of foot rails



2051-10

Commande par pédale
Foot control
(réf./ref: 2050-10/15)



2051-21

Commande par pédale
Foot control
(réf./ref: 2050-20/30)



2051-31

Commande par pédale
Foot control
(réf./ref: 2050-50)



166

Paire d'étaux
Pair of clamps

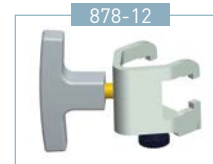

878-12

Étau coulissant pour rail
25x10 mm, ø 16/18 mm
Sliding clamp for
25x10 mm rail, ø 16/18 mm

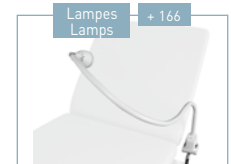

Lampes
Lamps +166

Se référer à la
documentation
Refer to the literature

Choix de selleries non-feu M1
Antibactérien
Choice of M1 fire retardant
and antibacterial upholstery

Classic

- 32 - BLEU / BLUE
- 93 - COTTAGE / COTTAGE
- 35 - ROUGE / RED
- 34 - JAUNE / YELLOW
- 91 - BLANC / WHITE
- 92 - MARINE / MARINE
- 56 - OBSCURE / DARKNESS
- 57 - ANTISTATIQUE / ANTISTATIC
Non classé M1 / Not classified M1

Vitamin

- 64 - RAISIN / GRAPE
- 67 - LAGON / LAGOON
- 66 - BONBON / SWEET
- 63 - CEDRAT / CEDRAT

Cosy

- 80 - CIEL / SKY
- 81 - VERT D'EAU / SEA GREEN
- 65 - LILAS / LILAC
- 96 - ETAIN / TIN
- 82 - GRIS SOURIS / MOUSE GREY
- 83 - NATUREL / NATURAL
- 84 - CHOCOLAT / CHOCOLATE

ANTIBACTERIAL / M1 FIRE RETARDANT / NON FEU M1 - ANTIBACTÉRIEN / M1 FIRE RETARDANT

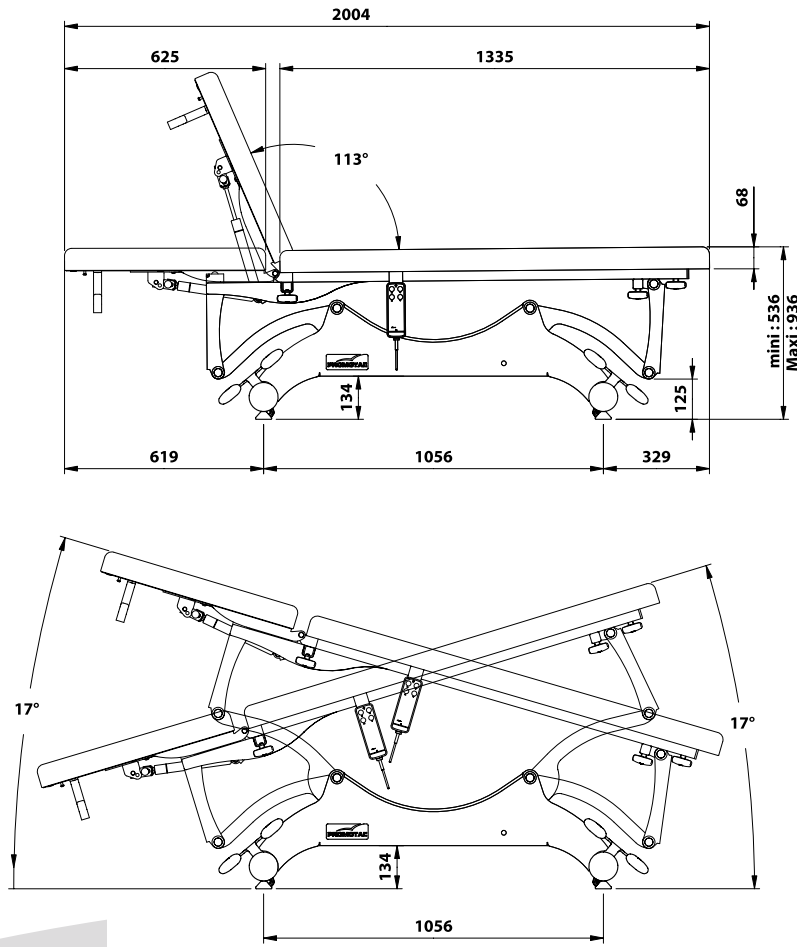

Poids net
Net weight

Divan / Couch 83 kg
Sellerie / Upholstery 21 kg

Poids brut
Gross weight

Divan / Couch 121 kg
Sellerie / Upholstery 25 kg

Volume

Divan / Couch 0,96 m³
Sellerie / Upholstery 0,28 m³

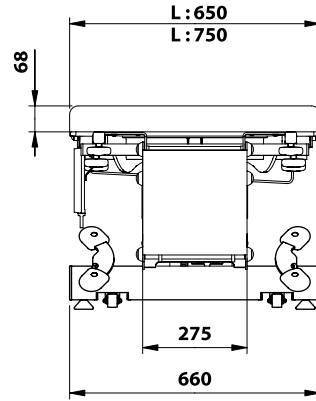

FE-05/19

